

**POLE BARNS
ACCESSORY BUILDINGS
LIVING AREAS IN POLE BARNS/ACCESSORY BUILDINGS**

BASIC CODE INFORMATION



**CHRISTIAN COUNTY
BUILDING REGULATIONS
DEPARTMENT**

**BUILDING INSPECTIONS
202 W. ELM
OZARK, MISSOURI**

**Telephone 417-581-6064
Fax 417-581-6054**

INTRODUCTION

THIS INFORMATION IS BASED ON THE 2006 INTERNATIONAL ONE- AND TWO- FAMILY DWELLING CODE AND OTHER ADOPTED CHRISTIAN COUNTY AMENDMENTS.

THIS HANDOUT IS ONLY PROVIDED AS A CONVENIENT SOURCE FOR BASIC INFORMATION AND DOES NOT ADDRESS ALL THE CODES NOR DOES THIS INFORMATION TAKE THE PLACE OF ANY ADOPTED CODE OR AMENDMENTS.

THIS INFORMATION SIMPLY ACTS AS AN INSTRUMENT TO BETTER PRESENT AND CLARIFY SOME OF THE CODE INTERPRETATIONS AND ENFORCEMENT AND DOES NOT REPRESENT THE REQUIREMENTS FOR ANY BUILDING THAT FALLS UNDER THESE OCCUPANCIES; ASSEMBLY, EDUCATION, FACTORY & INDUSTRIAL, HIGH HAZARD, INSTITUTIONAL, MERCANTILE, RESIDENTIAL (other than one and two family), AND THESE USE GROUPS; STORAGE, UTILITY AND MISCELLANEOUS OCCUPANCIES, WHERE THE BUILDINGS ARE NOT AN ACCESSORY TO ONE-AND TWO-FAMILY DWELLINGS AND WOULD NOT BE CLASSIFIED AS AN AGRICULTURAL STRUCTURE.

ANY POLE TYPE STRUCTURE, CONTAINING HABITABLE LIVING SPACE, MUST HAVE COMPLETE, ENGINEER STAMPED PLANS.

REQUIRED INSPECTIONS

FOOTINGS FRAMING FINAL

ADDITIONAL INSPECTIONS REQUIRED WHEN ANY OF THE FOLLOWING ARE INSTALLED

**IN-GROUND PLUMBING
ELECTRICAL
PLUMBING
MECHANICAL**

**METERS (Gas and/or Electric)
SEWER OR SEPTIC**

FOOTING INSPECTION/POLE HOLES: Commonly made after the excavation is completed. All property pins must be visible. **Pole holes** must be excavated with the required gravel in the bottom. **Formed footings** require the forms erected and required reinforcing steel in place prior to the placement of concrete.

IN-GROUND OR UNDERSLAB PLUMBING INSPECTION: All joints and piping in place and visible prior to concrete.

ELECTRICAL, MECHANICAL, & PLUMBING ROUGH-IN INSPECTION: These inspections are required before a framing inspection and prior to insulation or sheet rock inspection.

FRAMING INSPECTION: All electrical, mechanical, plumbing rough-ins, and all framing, fire-stopping, draft stopping, and bracing in place. Inspection conducted and prior to insulation or sheet rock installation.

ELECTRICAL METER INSPECTION: Electrical service equipment, service wiring, bonding, main disconnect, grounding in place, before meter will be approved.

GAS METER INSPECTION: Gas service to building must be installed by the gas company. Gas line installed from meter to gas fired equipment or appliance inside of structure, with twenty (20) pounds of air pressure on the line. Furnace must be ready for operation before gas meter will be released.

FINAL INSPECTION: Building, yard grading and all phases of construction complete. Inspection must be performed before occupancy or items are moved into the structure.

INSPECTIONS

It is the responsibility of the person and/or agent listed as the owner on the permit to obtain the proper inspections. The failure to obtain the proper inspections will result in the uncovering of work.

EXAMPLE: Placing poles or concrete in footing holes or forms before being approved by the building inspector.

THE PERMIT NUMBER OR ADDRESS IS REQUIRED TO BE POSTED and VISIBLE FROM THE STREET AT ALL TIMES DURING THE CONSTRUCTION. INSPECTIONS WILL NOT BE CONDUCTED IF THIS INFORMATION IS NOT POSTED.

A PERMANENT ADDRESS MUST BE POSTED BEFORE A FINAL INSPECTION IS CONDUCTED.

REQUEST FOR INSPECTIONS: All inspections must be called in to the Christian County Building Inspections Department by **8:00 A.M.**, inspections called **after 8:00 A.M.** will be scheduled for the next business day.

Inspections are conducted according to the inspectors' route. If you have a special situation you will need to contact the inspector by **8:15 A.M.** on the day that you are requesting the inspection.

TO SCHEDULE AN INSPECTION: Call **417-581-6064**. We will require the following information: Permit number, address, individuals name requesting the inspection and a contact telephone number.

BUILDING PLANNING

DESIGN LOADS: Roof Live Load – 20 PSF
Ground Snow Load – 20 PSF
Wind Speed – 90 MPH
Seismic Design Category- B
Soil Minimum Bearing Capacity – 2,500 PSF

ENGINEERING REQUIREMENTS: A Missouri licensed design professional is required to design the following;

Other loads such as loft areas, hoist or other attached loads require a design for the footings/piers and structure.

Any building pad that has fill material placed on it shall have a compaction test. The fill material is required to be engineered from the bottom of the fill to the top of the fill. The compaction tests are required to be submitted to Christian County Building Inspections with the application for the building permit.

Any wood pole barn structure that has a width exceeding forty (40) feet or exceeds 5,000 square feet in area requires a designed set of plans. Plans are to indicate the footings or piers, column attachments, structure and design loads. Plans are to be submitted to Christian County Building Inspections with the application for the building permit.

All wood trusses. Submit shop drawings and certification.

All metal structures. Complete set of plans and shop drawings indicating footings or piers, column attachments, structure and design loads. Plans are to be submitted to Christian County Building Inspections with the application for the building permit.

Pole foundation depths that are shallower than the required depth indicated in the charts in this document for minimum hole depth.

POSTS: Wood posts are required to be a minimum six inch by six inch (6" X 6") ACQ or CCA treated.

Exits: The distance from the egress door to the most remote area can not exceed seventy-five (75) feet. Over seventy five (75) feet will require two (2) or more egress doors located remotely from each other.

ELECTRICAL REQUIREMENTS FOR BARN/ACCESSORY STRUCTURES: Installed according to the adopted National Electric Code.

HEATING-AIR CONDITIONING, PLUMBING AND GAS SERVICE: Installed according to the adopted International Codes.

POLE BARN STRUCTURES

FOOTING REQUIREMENTS

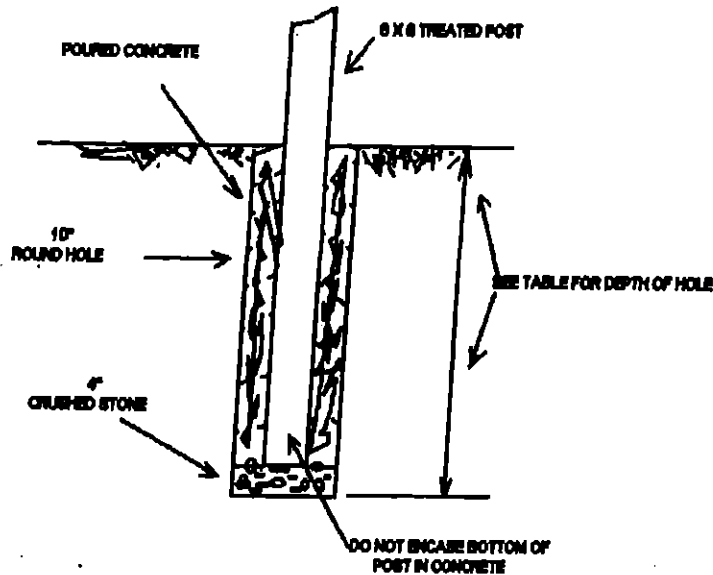

When the posts are placed in concrete the diameter of the hole is required to be 10 inches. The depth of the footing holes are according to the tables located on Page 7. The bottom of the footing hole is required to have 4 inches of crushed stone placed under the post. **DO NOT PLACE CONCRETE UNDER THE POST.**

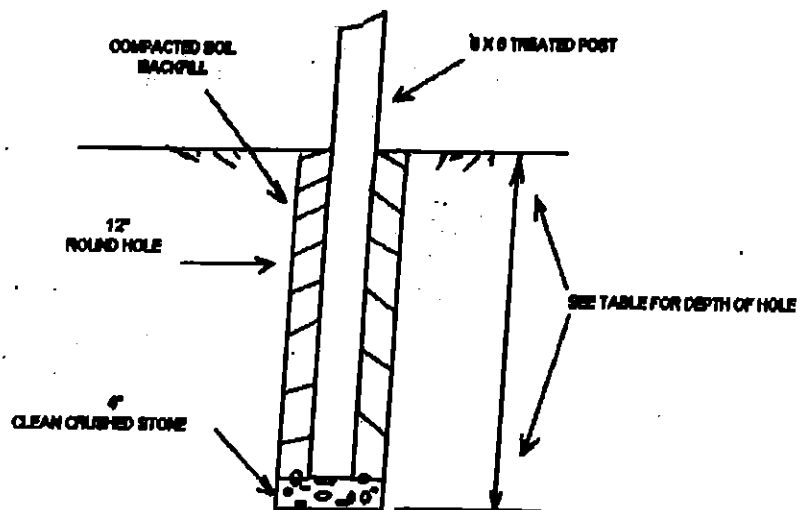

When posts are placed in soil the diameter of the hole is required to be 12 inches. The depth of the hole is according to the tables located on Page 7. The bottom of the footing hole is required to have 4 inches of crushed stone under the post. The soil placed around the pole is to be compacted.

**POLES ARE REQUIRED TO BE A MINIMUM 6"X6"
TREATED POST**

POLES SPACED 8 FEET ON CENTER

DEPTH OF FOUNDATION HOLES

Maximum Clear Truss Span	Soil Backfill			Concrete Backfill		
	Eave Height From Finish Grade			Eave Height From Finish Grade		
	8 ft.	10 ft.	14 ft.	8 ft.	10 ft.	14 ft.
20 ft.	29"	37"	52"	28"	29"	40"
30 ft.	32"	40"	54"	28"	31"	41"
40 ft.	34"	42"	55"	28"	32"	42"

POLES SPACED 10 FEET ON CENTER

DEPTH OF FOUNDATION HOLES

Maximum Clear Truss Span	Soil Backfill			Concrete Backfill		
	Eave Height From Finish Grade			Eave Height From Finish Grade		
	8 ft.	10 ft.	14 ft.	8 ft.	10 ft.	14 ft.
20 ft.	34"	43"	60"	28"	33"	46"
30 ft.	37"	46"	62"	29"	35"	48"
40 ft.	40"	49"	64"	31"	37"	49"

Shallower pole depths must be engineered

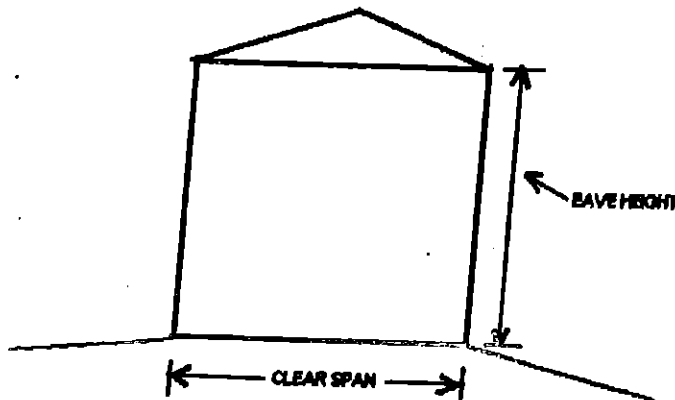

TRUSS ATTACHED TO EVERY POST

Truss Notched Into Post: Notch is to be no deeper than 1 1/2" into side of post. The truss is to be attached to the post with one (1) one-half inch carriage bolt with nut and washer. A number 2 grade 2 X 10 ledger or rim is required to be attached from post to post with two (2) one-half inch carriage bolts and washers. **LEDGER BOARD IS NOT ILLUSTRATED IN THE FOLLOWING EXAMPLE.**

TRUSS ATTACHMENT TO NOTCHED POST

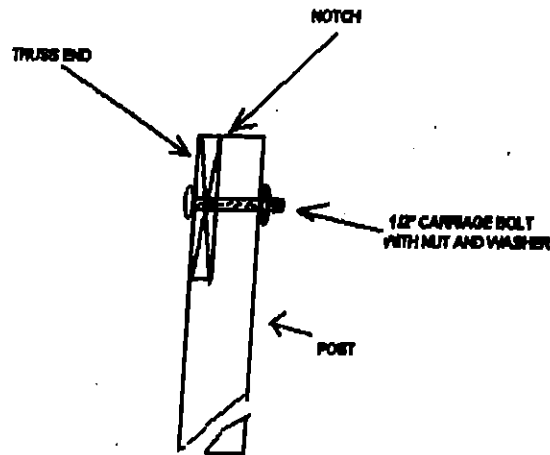

Truss Attached to Post: When the truss is attached on the side of every post the truss is to be attached with one (1) one-half inch carriage bolt with washers and nuts. A number 2 grade 2 X 10 ledger or rim is required to be attached from post to post with two (2) one-half inch carriage bolts and washers. A minimum four (4) foot long 2 X 4 is to be attached under the truss to the post with three (3) 1/2" by 5" lag screws spaced a maximum of six (6) inches from each end and one (1) in the middle.

TRUSS ATTACHMENT TO POST WITH LEDGER BOARD

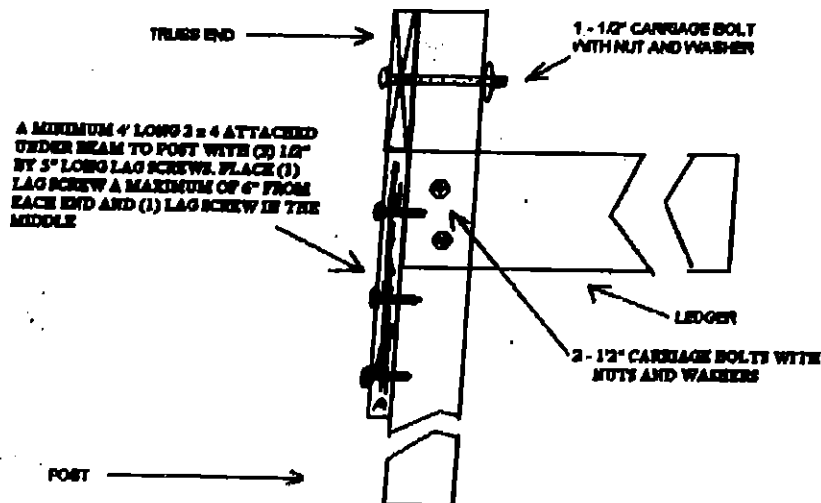

PURLINS

MINIMUM 2 X 4 PURLINS SPACED A MAXIMUM OF 24" ON CENTER
PURLINS MUST BE CONNECTED TO THE TRUSS WITH AN APPROVED MECHANICAL CONNECTION
PURLINS MAY BE PLACED BETWEEN TRUSSES OR ON EDGE ON TOP OF THE TRUSSES

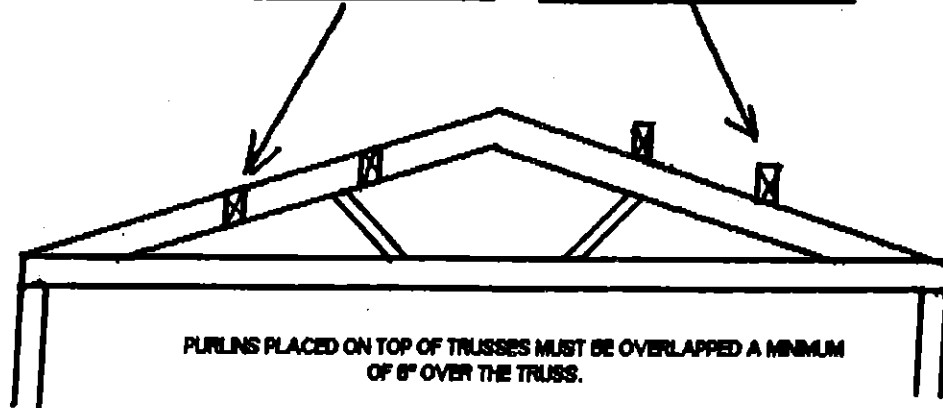

PURLINS PLACED ON TOP OF TRUSSES MUST BE OVERLAPPED A MINIMUM OF 6" OVER THE TRUSS.

NAILERS

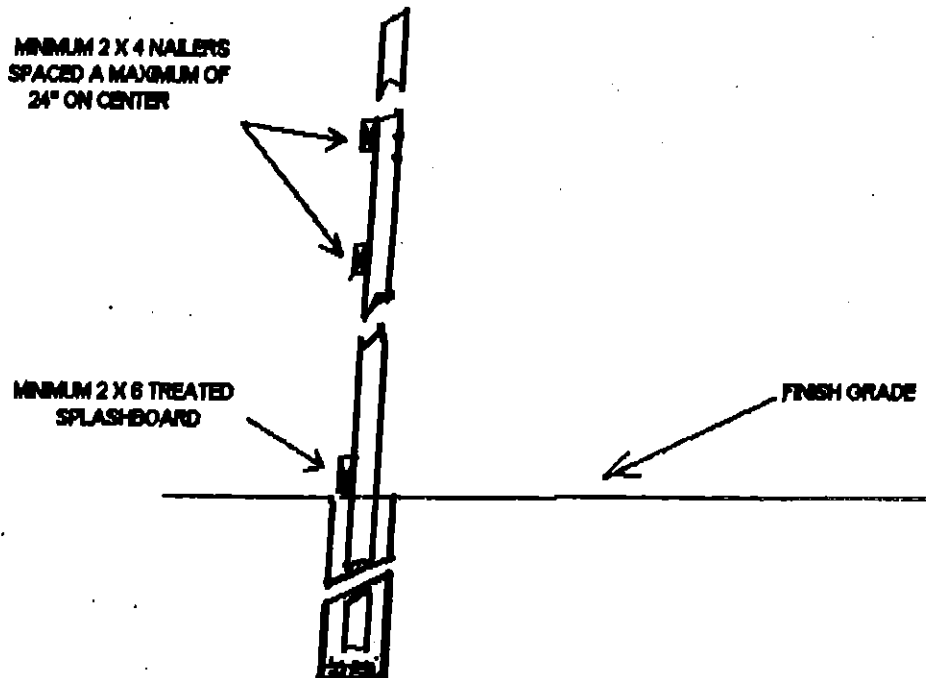

MINIMUM 2 X 4 NAILERS
SPACED A MAXIMUM OF
24" ON CENTER

MINIMUM 2 X 6 TREATED
SPLASHBOARD

FINISH GRADE

All walls shall be braced and sheathed.

CONVENTIONAL CONSTRUCTION

The following diagrams and tables represent the requirements for construction using spread footings, rafters and ceiling joist combination. These tables are not used with an engineered truss system and pole construction.

Typical Footing Details

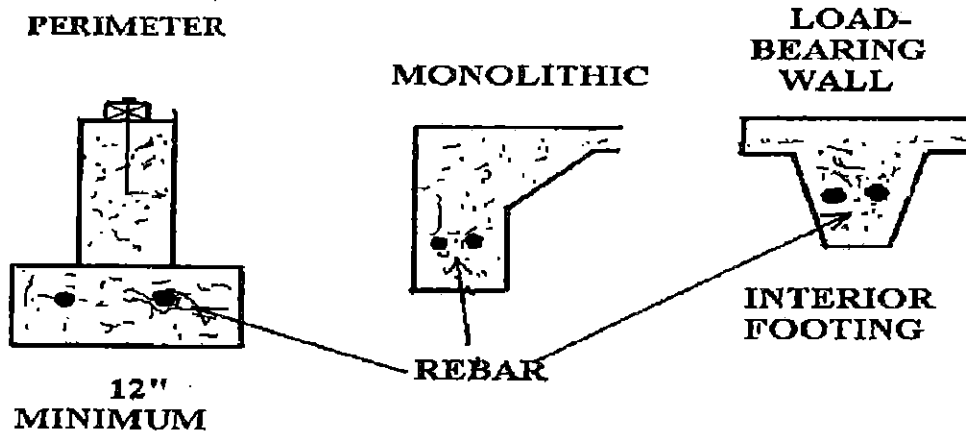

GIRDER and HEADER SPANS FOR EXTERIOR BEARING WALLS

		Building Width in Feet					
		20		28		36	
HEADERS SUPPORTING	SIZE	SPAN	# JACK STUDS	SPAN	# JACK STUDS	SPAN	# JACK STUDS
Roof and ceiling							
	2-2 X 4	3-6	1	3-2	1	2-10	1
	2-2 X 6	5-5	1	4-8	1	4-2	1
	2-2 X 8	6-10	1	5-11	2	5-4	2
	2-2 X 10	8-5	2	7-3	2	6-6	2
	2-2 X 12	9-9	2	8-5	2	7-6	2
	3-2 X 8	8-4	1	7-5	1	6-8	1
	3-2 X 10	10-9	1	9-1	2	6-2	2
	3-2 X 12	12-2	2	10-7	2	9-5	2
	4-2 X 8	9-2	1	6-4	1	7-8	1
	4-2 X 1	11-8	1	10-6	1	9-5	2
	4-2 X 12	13-1	1	12-2	2	10-11	2

ROOF-CEILING CONSTRUCTION

TABLE R802.5.1(1)
RAFTER SPANS FOR COMMON LUMBER SPECIES
 (Roof live load=20 psf, ceiling not attached to rafters, L/Δ = 180)

RAFTER SPACING (Inches)	SPECIES AND GRADE	DEAD LOAD = 10 psf					DEAD LOAD = 20 psf					
		2 x 4	2 x 6	2 x 8	2 x 10	2 x 12	2 x 4	2 x 6	2 x 8	2 x 10	2 x 12	
		Maximum rafter spans*										
		(feet - inches)	(feet - inches)	(feet - inches)	(feet - inches)	(feet - inches)	(feet - inches)	(feet - inches)	(feet - inches)	(feet - inches)	(feet - inches)	
12	Douglas fir-larch	SS	11-6	18-0	23-9	Note b	Note b	11-6	18-0	23-5	Note b	Note b
	Douglas fir-larch	#1	11-1	17-4	22-5	Note b	Note b	10-6	15-4	19-5	23-9	Note b
	Douglas fir-larch	#2	10-1	16-7	21-0	25-8	Note b	9-10	14-4	18-2	22-3	25-9
	Douglas fir-larch	#3	8-7	12-6	15-10	19-5	22-6	7-5	10-10	13-9	16-9	19-6
	Hem-fir	SS	10-10	17-0	22-5	Note b	Note b	10-10	17-0	22-5	Note b	Note b
	Hem-fir	#1	10-7	16-8	21-10	Note b	Note b	10-3	14-11	18-11	23-2	Note b
	Hem-fir	#2	10-1	15-11	20-8	25-3	Note b	9-8	14-2	17-11	21-11	25-5
	Hem-fir	#3	8-7	12-6	15-10	19-5	22-6	7-5	10-10	13-9	16-9	19-6
	Southern pine	SS	11-3	17-8	23-4	Note b	Note b	11-3	17-8	23-4	Note b	Note b
	Southern pine	#1	11-1	17-4	22-11	Note b	Note b	11-1	17-3	21-9	25-10	Note b
	Southern pine	#2	10-10	17-0	22-5	Note b	Note b	10-6	15-1	19-5	23-2	Note b
	Southern pine	#3	9-1	13-6	17-2	20-3	24-1	7-11	11-8	14-10	17-6	20-11
	Spruce-pine-fir	SS	10-7	16-8	21-11	Note b	Note b	10-7	16-8	21-9	Note b	Note b
	Spruce-pine-fir	#1	10-4	16-3	21-0	25-8	Note b	9-10	14-4	18-2	22-3	25-9
	Spruce-pine-fir	#2	10-4	16-3	21-0	25-8	Note b	9-10	14-4	18-2	22-3	25-9
	Spruce-pine-fir	#3	8-7	12-6	15-10	19-5	22-6	7-5	10-10	13-9	16-9	19-6
16	Douglas fir-larch	SS	10-5	16-4	21-7	Note b	Note b	10-5	16-0	20-3	24-9	Note b
	Douglas fir-larch	#1	10-0	15-4	19-5	23-9	Note b	9-1	13-3	16-10	20-7	23-10
	Douglas fir-larch	#2	9-10	14-4	18-2	22-3	25-9	8-6	12-5	15-9	19-3	22-4
	Douglas fir-larch	#3	7-5	10-10	13-9	16-9	19-6	6-5	9-5	11-11	14-6	16-10
	Hem-fir	SS	9-10	15-6	20-5	Note b	Note b	9-10	15-6	19-11	24-4	Note b
	Hem-fir	#1	9-8	14-11	18-11	23-2	Note b	8-10	12-11	16-5	20-0	23-3
	Hem-fir	#2	9-2	14-2	17-11	21-11	25-5	8-5	12-3	15-6	18-11	22-0
	Hem-fir	#3	7-5	10-10	13-9	16-9	19-6	6-5	9-5	11-11	14-6	16-10
	Southern pine	SS	10-3	16-1	21-2	Note b	Note b	10-3	16-1	21-2	Note b	Note b
	Southern pine	#1	10-0	15-9	20-10	25-10	Note b	10-0	15-0	18-10	22-4	Note b
	Southern pine	#2	9-10	15-1	19-5	23-2	Note b	9-1	13-0	16-10	20-1	23-7
	Southern pine	#3	7-11	11-8	14-10	17-6	20-11	6-10	10-1	12-10	15-2	18-1
	Spruce-pine-fir	SS	9-8	15-2	19-11	25-5	Note b	9-8	14-10	18-10	23-0	Note b
	Spruce-pine-fir	#1	9-5	14-4	18-2	22-3	25-9	8-6	12-5	15-9	19-3	22-4
	Spruce-pine-fir	#2	9-5	14-4	18-2	22-3	25-9	8-6	12-5	15-9	19-3	22-4
	Spruce-pine-fir	#3	7-5	10-10	13-9	16-9	19-6	6-5	9-5	11-11	14-6	16-10
19.2	Douglas fir-larch	SS	9-10	15-5	20-4	25-11	Note b	9-10	14-7	18-6	22-7	Note b
	Douglas fir-larch	#1	9-5	14-0	17-9	21-8	25-2	8-4	12-2	15-4	18-9	21-9
	Douglas fir-larch	#2	8-11	13-1	16-7	20-3	23-6	7-9	11-4	14-4	17-7	20-4
	Douglas fir-larch	#3	6-9	9-11	12-7	15-4	17-9	5-10	8-7	10-10	13-3	15-5
	Hem-fir	SS	9-3	14-7	19-2	24-6	Note b	9-3	14-4	18-2	22-3	25-9
	Hem-fir	#1	9-1	13-8	17-4	21-1	24-6	8-1	11-10	15-0	18-4	21-3
	Hem-fir	#2	8-8	12-11	16-4	20-0	23-2	7-8	11-2	14-2	17-4	20-1
	Hem-fir	#3	6-9	9-11	12-7	15-4	17-9	5-10	8-7	10-10	13-3	15-5
	Southern pine	SS	9-8	15-2	19-11	25-5	Note b	9-8	15-2	19-11	25-5	Note b
	Southern pine	#1	9-5	14-10	19-7	23-7	Note b	9-3	13-8	17-2	20-5	24-4
	Southern pine	#2	9-3	13-9	17-9	21-2	24-10	8-4	11-11	15-4	18-4	21-6
	Southern pine	#3	7-3	10-8	13-7	16-0	19-1	6-3	9-3	11-9	13-10	16-6
	Spruce-pine-fir	SS	9-1	14-3	18-9	23-11	Note b	9-1	13-7	17-2	21-0	24-4
	Spruce-pine-fir	#1	8-10	13-1	16-7	20-3	23-6	7-9	11-4	14-4	17-7	20-4
	Spruce-pine-fir	#2	8-10	13-1	16-7	20-3	23-6	7-9	11-4	14-4	17-7	20-4
	Spruce-pine-fir	#3	6-9	9-11	12-7	15-4	17-9	5-10	8-7	10-10	13-3	15-5

(continued)

TABLE R802.5.1(1)—continued
RAFTER SPANS FOR COMMON LUMBER SPECIES
 (Roof live load=20 psf, ceiling not attached to rafters, L/Δ = 180)

RAFTER SPACING (inches)	SPECIES AND GRADE	DEAD LOAD = 10 psf					DEAD LOAD = 20 psf					
		2 x 4	2 x 6	2 x 8	2 x 10	2 x 12	2 x 4	2 x 6	2 x 8	2 x 10	2 x 12	
		Maximum rafter spans*										
		(feet - inches)	(feet - inches)	(feet - inches)	(feet - inches)	(feet - inches)	(feet - inches)	(feet - inches)	(feet - inches)	(feet - inches)	(feet - inches)	
24	Douglas fir-larch	SS	9-1	14-4	18-10	23-4	Note b	8-11	13-1	16-7	20-3	23-5
	Douglas fir-larch	#1	8-7	12-6	15-10	19-5	22-6	7-5	10-10	13-9	16-9	19-6
	Douglas fir-larch	#2	8-0	11-9	14-10	18-2	21-0	6-11	10-2	12-10	15-8	18-3
	Douglas fir-larch	#3	6-1	8-10	11-3	13-8	15-11	5-3	7-8	9-9	11-10	13-9
	Hem-fir	SS	8-7	13-6	17-10	22-9	Note b	8-7	12-10	16-3	19-10	23-0
	Hem-fir	#1	8-4	12-3	15-6	18-11	21-11	7-3	10-7	13-5	16-4	19-0
	Hem-fir	#2	7-11	11-7	14-8	17-10	20-9	6-10	10-0	12-8	15-6	17-11
	Hem-fir	#3	6-1	8-10	11-3	13-8	15-11	5-3	7-8	9-9	11-10	13-9
	Southern pine	SS	8-11	14-1	18-6	23-8	Note b	8-11	14-1	18-6	22-11	Note b
	Southern pine	#1	8-9	13-9	17-9	21-1	25-2	8-3	12-3	15-4	18-3	21-9
	Southern pine	#2	8-7	12-3	15-10	18-11	22-2	7-5	10-8	13-9	16-5	19-3
	Southern pine	#3	6-5	9-6	12-1	14-4	17-1	5-7	8-3	10-6	12-5	14-9
	Spruce-pine-fir	SS	8-5	13-3	17-5	21-8	25-2	8-4	12-2	15-4	18-9	21-9
	Spruce-pine-fir	#1	8-0	11-9	14-10	18-2	21-0	6-11	10-2	12-10	15-8	18-3
	Spruce-pine-fir	#2	8-0	11-9	14-10	18-2	21-0	6-11	10-2	12-10	15-8	18-3
	Spruce-pine-fir	#3	6-1	8-10	11-3	13-8	15-11	5-3	7-8	9-9	11-10	13-9

*Check sources for availability of lumber in lengths greater than 20 feet.

SI: 1 inch = 25.4 mm, 1 foot = 304.8 mm, 1 pound per square foot = 0.0479 kPa.

The tabulated rafter spans assume that ceiling joists are located at the bottom of the attic space or that some other method of resisting the outward push of the rafters on the bearing walls, such as rafter ties, is provided at that location. When ceiling joists or rafter ties are located higher in the attic space, the rafter spans shall be multiplied by the factors given below:

H_C/H_R	Rafter Span Adjustment Factor
1/3	0.67
1/4	0.76
1/5	0.83
1/6	0.90
1/7.5 or less	1.00

where:

H_C = Height of ceiling joists or rafter ties measured vertically above the top of the rafter support walls.

H_R = Height of roof ridge measured vertically above the top of the rafter support walls.

*Span exceeds 26 feet in length.

TABLE R802.4(2)
 CEILING JOIST SPANS FOR COMMON LUMBER SPECIES
 (Uninhabitable attics with limited storage, live load = 20 psf, L/Δ = 240)

CEILING JOIST SPACING (Inches)	SPECIES AND GRADE	DEAD LOAD = 10 psf			
		2 x 4	2 x 6	2 x 8	2 x 10
		Maximum ceiling joist spans			
		(feet - Inches)	(feet - Inches)	(feet - Inches)	(feet - Inches)
12	Douglas fir-larch SS	10-5	16-4	21-7	Note a
	Douglas fir-larch #1	10-0	15-9	20-1	24-6
	Douglas fir-larch #2	9-10	14-10	18-9	22-11
	Douglas fir-larch #3	7-8	11-2	14-2	17-4
	Hem-fir SS	9-10	15-6	20-5	Note a
	Hem-fir #1	9-8	15-2	19-7	23-11
	Hem-fir #2	9-2	14-5	18-6	22-7
	Hem-fir #3	7-8	11-2	14-2	17-4
	Southern pine SS	10-3	16-1	21-2	Note a
	Southern pine #1	10-0	15-9	20-10	Note a
	Southern pine #2	9-10	15-6	20-1	23-11
	Southern pine #3	8-2	12-0	15-4	18-1
	Spruce-pine-fir SS	9-8	15-2	19-11	25-5
	Spruce-pine-fir #1	9-5	14-9	18-9	22-11
	Spruce-pine-fir #2	9-5	14-9	18-9	22-11
	Spruce-pine-fir #3	7-8	11-2	14-2	17-4
16	Douglas fir-larch SS	9-6	14-11	19-7	25-0
	Douglas fir-larch #1	9-1	13-9	17-5	21-3
	Douglas fir-larch #2	8-9	12-10	16-3	19-10
	Douglas fir-larch #3	6-8	9-8	12-4	15-0
	Hem-fir SS	8-11	14-1	18-6	23-8
	Hem-fir #1	8-9	13-5	16-10	20-8
	Hem-fir #2	8-4	12-8	16-0	19-7
	Hem-fir #3	6-8	9-8	12-4	15-0
	Southern pine SS	9-4	14-7	19-3	24-7
	Southern pine #1	9-1	14-4	18-11	23-1
	Southern pine #2	8-11	13-6	17-5	20-9
	Southern pine #3	7-1	10-5	13-3	15-8
	Spruce-pine-fir SS	8-9	13-9	18-1	23-1
	Spruce-pine-fir #1	8-7	12-10	16-3	19-10
	Spruce-pine-fir #2	8-7	12-10	16-3	19-10
	Spruce-pine-fir #3	6-8	9-8	12-4	15-0
19.2	Douglas fir-larch SS	8-11	14-0	18-5	23-4
	Douglas fir-larch #1	8-7	12-6	15-10	19-5
	Douglas fir-larch #2	8-0	11-9	14-10	18-2
	Douglas fir-larch #3	6-1	8-10	11-3	13-8
	Hem-fir SS	8-5	13-3	17-5	22-3
	Hem-fir #1	8-3	12-3	15-6	18-11
	Hem-fir #2	7-10	11-7	14-8	17-10
	Hem-fir #3	6-1	8-10	11-3	13-8
	Southern pine SS	8-9	13-9	18-1	23-1
	Southern pine #1	8-7	13-6	17-9	21-1
	Southern pine #2	8-5	12-3	15-10	18-11
	Southern pine #3	6-5	9-6	12-1	14-4
	Spruce-pine-fir SS	8-3	12-11	17-1	21-8
	Spruce-pine-fir #1	8-0	11-9	14-10	18-2
	Spruce-pine-fir #2	8-0	11-9	14-10	18-2
	Spruce-pine-fir #3	6-1	8-10	11-3	13-8

(continued)

TABLE R802.4(2)—continued
CEILING JOIST SPANS FOR COMMON LUMBER SPECIES
 (Uninhabitable attics with limited storage, live load = 20 psf, L/Δ = 240)

CEILING JOIST SPACING (inches)	SPECIES AND GRADE	DEAD LOAD = 10 psf			
		2 x 4	2 x 6	2 x 8	2 x 10
		Maximum Ceiling Joist Spans			
		(feet - inches)	(feet - inches)	(feet - inches)	(feet - inches)
24	Douglas fir-larch SS	8-3	13-0	17-1	20-11
	Douglas fir-larch #1	7-8	11-2	14-2	17-4
	Douglas fir-larch #2	7-2	10-6	13-3	16-3
	Douglas fir-larch #3	5-5	7-11	10-0	12-3
	Hem-fir SS	7-10	12-3	16-2	20-6
	Hem-fir #1	7-6	10-11	13-10	16-11
	Hem-fir #2	7-1	10-4	13-1	16-0
	Hem-fir #3	5-5	7-11	10-0	12-3
	Southern pine SS	8-1	12-9	16-10	21-6
	Southern pine #1	8-0	12-6	15-10	18-10
	Southern pine #2	7-8	11-0	14-2	16-11
	Southern pine #3	5-9	8-6	10-10	12-10
	Spruce-pine-fir SS	7-8	12-0	15-10	19-5
	Spruce-pine-fir #1	7-2	10-6	13-3	16-3
	Spruce-pine-fir #2	7-2	10-6	13-3	16-3
	Spruce-pine-fir #3	5-5	7-11	10-0	12-3

Check sources for availability of lumber in lengths greater than 20 feet.

For SI: 1 inch = 25.4 mm, 1 foot = 304.8 mm, 1 pound per square foot = 0.0479 kPa.

a. Span exceeds 26 feet in length.

LIVING QUARTERS in BARNS/ ACCESSORY BUILDINGS

Must comply with the adopted International One and Two Family Dwelling Code and the following;

FOOTING REQUIREMENTS

- **Footings are required to extend to the exterior wall side of the supporting post on a pole type structure. (SEE PAGE 16)**
- **Bottom of footing is required to be a minimum of eighteen (18) inches below finish grade.**
- **The top of the footing or foundation shall extend above grade where as the finish backfill or yard grade is a minimum of six (6) inches below the top of the finished floor level.**
- **Footings shall be a minimum of twelve (12) inches wide, eight (8) inches thick with two (2) rows of #4 or ½ inch rebar in place before the concrete is poured. Rebar is to be supported a minimum of four (4) inches from the bottom of the footing, lapped and tied together.**

WALLS and CEILINGS

- **All interior walls shall be fastened to the concrete floor with a mechanical fastener spaced a maximum of six (6) feet on centers. (POWER NAILING IS NOT ACCEPTED)**
- **All walls on the interior of the exterior walls around the living area and the wall between the barn/accessory structure and living area are to be insulated and covered with approved wall covering from the floor to the ceiling or roof.**
- **The wall between the living area and the barn/accessory structure is required to be covered with a minimum of 1/2" gypsum board applied to the barn or garage side.**
- **The area over the living area is required to be insulated.**
- **The ceiling of the living area is required to have a minimum of 1/2" gypsum board applied to the bottom of the ceiling.**

EGRESS

- **At least one (1) egress door must exit directly to the exterior of the living area. The required door shall be a side-hinged door not less than thirty-six (36) inches in width and six feet-eight inches (6' 8") in height.**
- **All egress doors are required to be opened from the egress side without the use of a key.**
- **All areas used for sleeping rooms must have one (1) direct egress to the exterior of the structure, either a window or door.**

- **Windows in a sleeping room shall be as follows;**

1. **The unit must be operable from the inside to a full clear opening without the use of a key, tool, or special knowledge.**
2. **The sill height is not to be more than 44 inches above the floor.**
3. **The net clear opening requirement is to be obtained by normal operation of the window from the inside.**
4. **Minimum net clear opening shall be 5.7 square feet or 821 square inches for windows located more than 44 inches above the finished grade adjacent to the window. Windows with the sill height 44 inches or less to the finished grade adjacent to the window shall be a minimum net clear opening of 5 square feet or 720 square inches.**
5. **Minimum window opening height is 24 inches and the minimum opening width is 20 inches. EXAMPLE: A window with a height of 24 inches would require a width greater than 20 inches to meet the required opening and a window with a width of 20 inches would require a window with a height greater than 24 inches to meet the required opening.**

OPENINGS BETWEEN LIVING AREA AND BARN/ACCESSORY STRUCTURE

- **No door or window can open into the sleeping area from the barn/accessory structure.**
- **A door from the barn/accessory structure opening into the living area (not allowed in sleeping area) must be a solid wood door a minimum of not less than 1 3/8 inch in thickness, solid or honeycomb steel door no less than 1 3/8 inch thickness or a 20-minute fire rated door. Panel doors do not have the required rating or thickness.**
- **Windows are not allowed between the living area and barn/accessory structure.**

SMOKE ALARMS

- **Required in all sleeping areas and outside of sleeping areas.**
- **Smoke alarms are required to receive their primary power source from the building wiring and have battery back up power.**
- **Smoke alarms are to be interconnected so all alarms will activate when one alarm is activated.**

ELECTRIC: Must comply with adopted National Electric Code.

HEATING/AIR CONDITIONING, PLUMBING and GAS SERVICE:
Must comply with the adopted International One and Two Family Building Code and Amendments.

FOOTING FOR LIVING SPACE IN POLE STRUCTURE

